



Title: Value chain design to open a recycling plant in the municipalities of Huauchinango-Xicotepec, Puebla

Authors: GONZÁLEZ-MUÑOZ, Lilian, SOTO-LEYVA, Yasmin and AHUACATITLA-PÉREZ, José Miguel

Editorial label ECORFAN: 607-8695

BCIERMMI Control Number: 2021-01

BCIERMMI Classification (2021): 271021-0001

Pages: 15

RNA: 03-2010-032610115700-14

ECORFAN-México, S.C.

143 – 50 Itzopan Street

La Florida, Ecatepec Municipality

Mexico State, 55120 Zipcode

Phone: +52 1 55 6159 2296

Skype: ecorfan-mexico.s.c.

E-mail: contacto@ecorfan.org

Facebook: ECORFAN-México S. C.

Twitter: @EcorfanC

www.ecorfan.org

Holdings

Mexico	Colombia	Guatemala
Bolivia	Cameroon	Democratic
Spain	El Salvador	Republic
Ecuador	Taiwan	of Congo
Peru	Paraguay	Nicaragua

Introduction

The indices of impact on the environment in Mexico grow exponentially to alarming levels, in recent years various problems have contributed to the generation of the aforementioned problem one of the factors with the greatest presence focuses on the availability and accumulation of various domestic solid waste in developing countries, which do not have physical infrastructures assigned as warehouses or processing units to promote the improvement of recycling systems; Due to the existence of a feasibility analysis that supports a proposal for the construction of validated recycling plants through the application of quantitative and qualitative tools. In response to the above, a correlational study is presented through the analysis of the "VSM" value chain for the opening of a recycling plant in 2 municipalities located in the Sierra Norte of the State of Puebla. In the first instance, a feasibility study was applied analyzing the habits and opinions of the inhabitants of the aforementioned area, then the value chain was created by identifying the main products to be manufactured, the potential suppliers and the target market. In this way, the cost margins are also calculated in comparison with the already established values of similar products. In order to optimize the production process, a mapping of the value stream is designed, determining the optimal operations involved in the processing of the selected waste. Subsequently, a prototype of a potentially recyclable MSW processing line is designed, in the SolidWorks technological software it shows the necessary machinery for each operating station. Applied research will enrich the sustainable development of the region by directly contributing to Sustainable Development Goal number 12 of the 2030 Agenda (SDG 12), efficiently managing a work system for the elimination of solid waste from the inhabitants, managing efficiently the availability of material resources of the municipalities.

Methodology

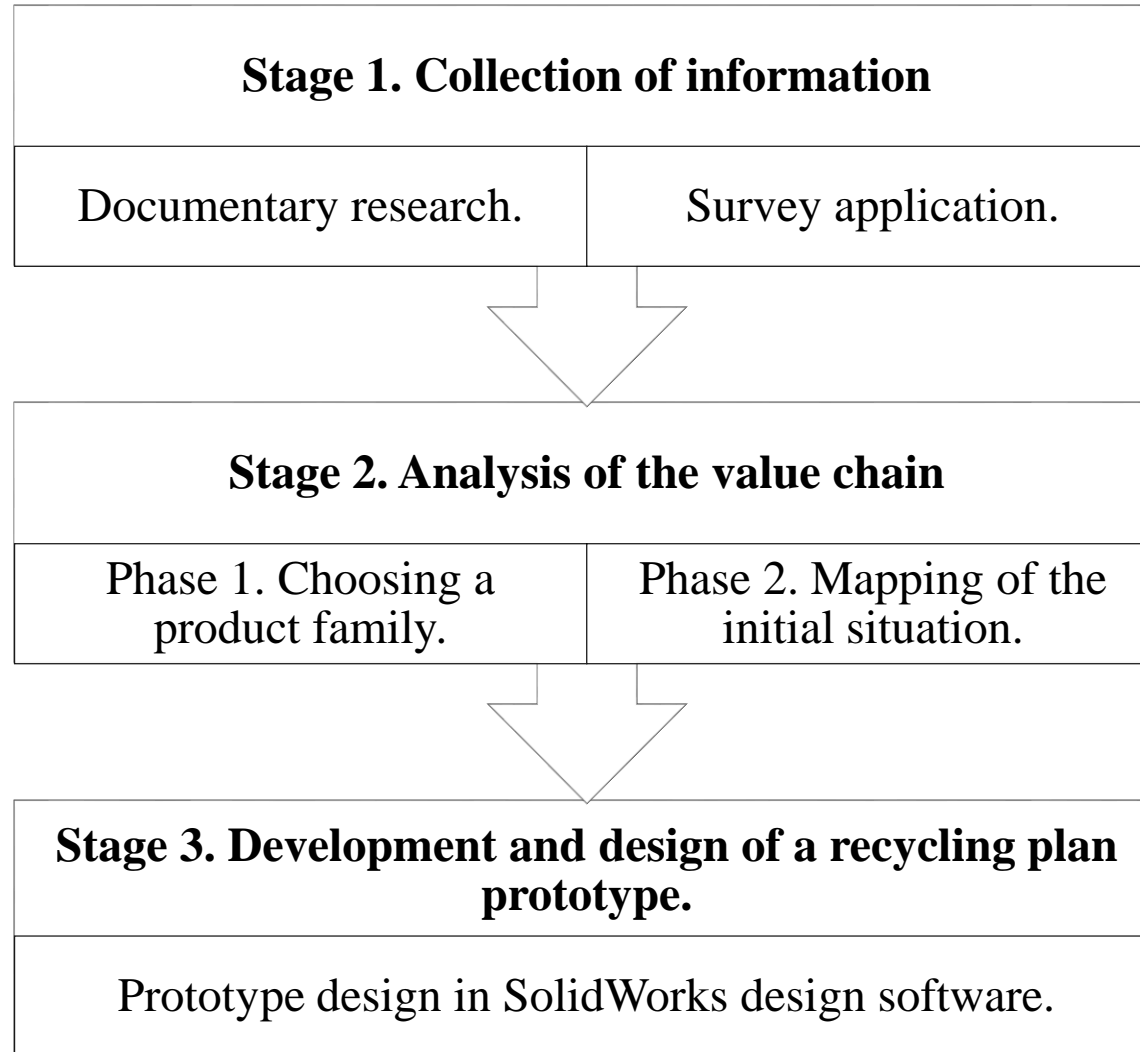

Consultation Source: Own elaboration.

Stage 1. Collection of information to determine degree of need and acceptance of the opening of a recycling plant

Núm.	Question
1	¿How many inhabitants are part of your household?
2	¿How do you rate the garbage problema in your locality, neighborhood, or municipality?
3	How much waste do you normally accumulate per day?
4	¿In your home do you have the habit of separating recycable garbage (PET, paper and cardboard) and classify?
5	It? If you separate and classify PET, cardboard and paper in your home what do you do with them?
6	¿Do you know of any program, campaigns or movements on the classification of recyclable waste?
7	¿Would it be integrated into programs for the separation and and classification of reciclables?
8	¿If you had the opportunity to generate income with your recyclable solid waste (PET, cardboard, paper) through separation and classification, would you carry out recycling processes?

Value corresponding to the Gauss Z	1.96
Expected prevalence of the parameter to be evaluated, in case of unknown and, considering equal probabilities to make the simple size larger.	p 0.5
1-p, 1-.5	q 0.5
Size of the population to study.	N 112,656
Mistake that is expected to be made with a good requerement of sampling.	e .05

$$n = \frac{N * z_a^2 * p * q}{e^2 * (N - 1) + z_a^2 * p * q}$$

$$= \frac{(112656 * 1.96^2 * .5 * .5)}{((.05^2 * 112655)) + (1.96^2 * .5 * .5)} = 382.857$$

Consultation Source: Own elaboration.

Stage 2 Analysis of the supply chain

Phase 1. Choosing a product family.

Phase 2. Mapping of the initial situation.

Type of waste	Percentage
Organic	50%
Potentially recyclable	30%
Others	20%
TOTAL	100%

Consultation Source: SEMARNAT

Stage 3 Development and design of a recycling plant prototype

Considering what was obtained in the value chain mapping, in which the tools, limitations and procedures necessary for the optimal operation of a recycling plant are detailed, the design of the plant prototype will be carried out, this through the software SolidWorks design technology.

Results

Results of the surveys

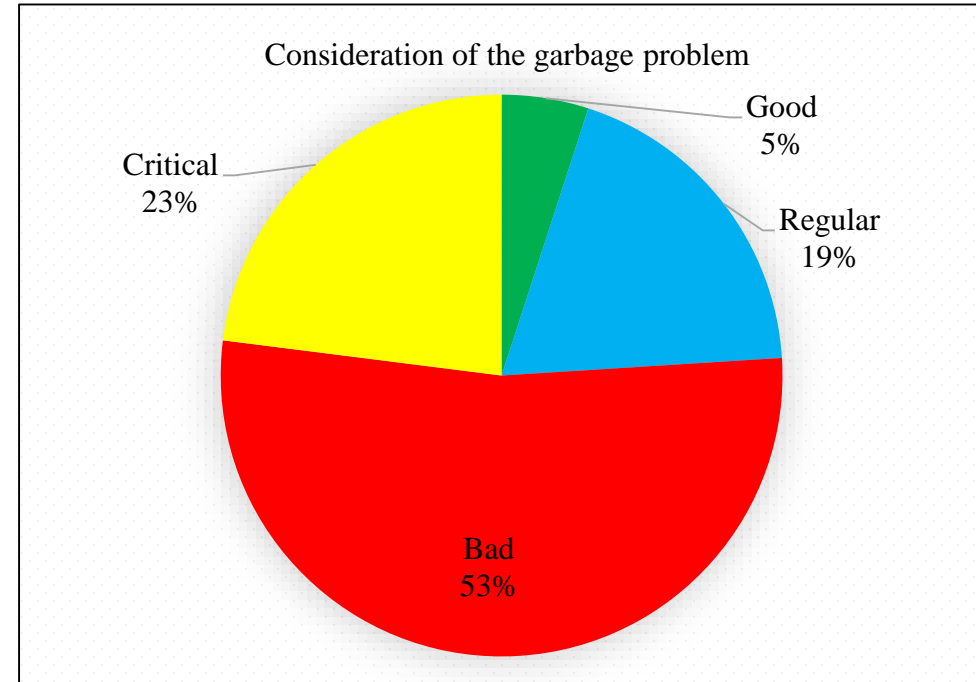
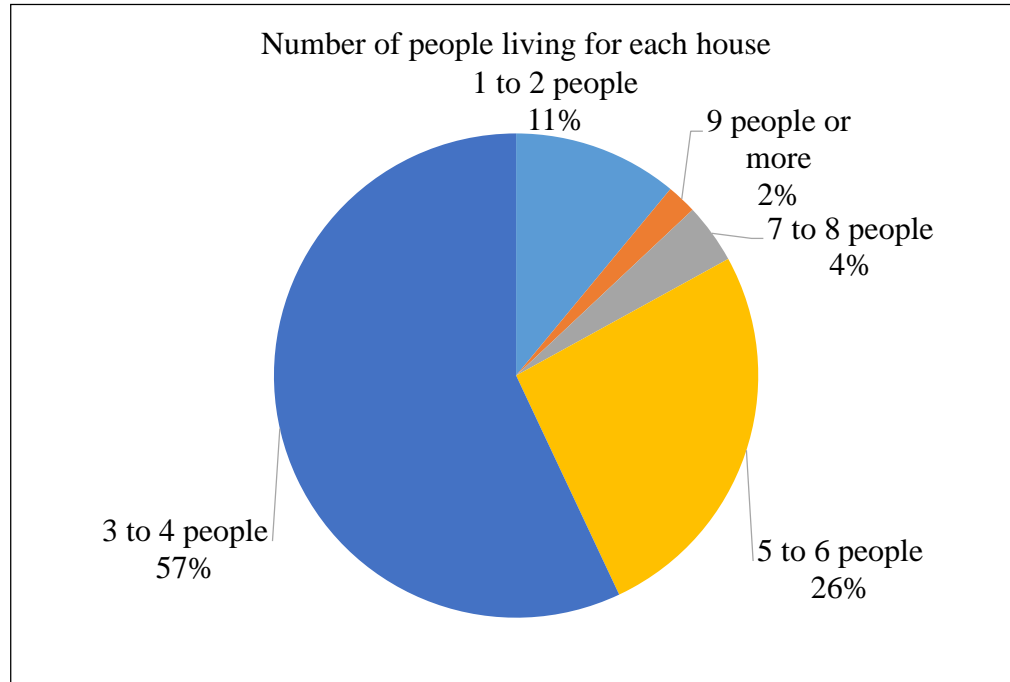

Consultation Source: Own elaboration with data obtained from the survey

Amount of garbage to collect

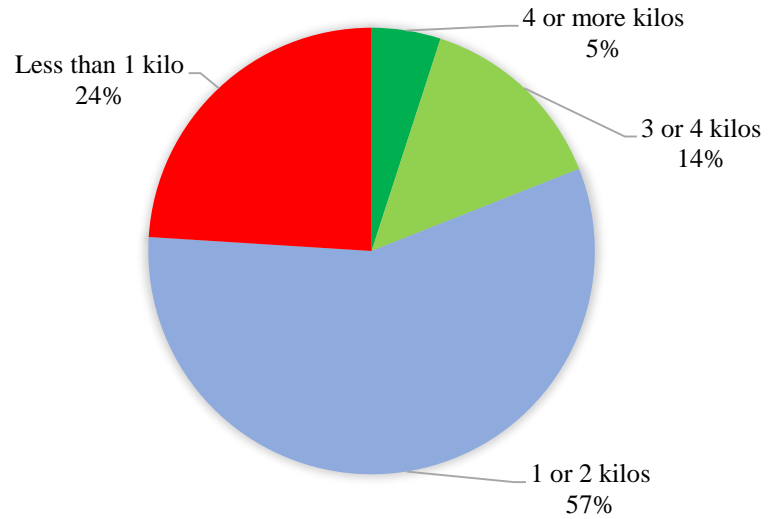

Garbage selection habits

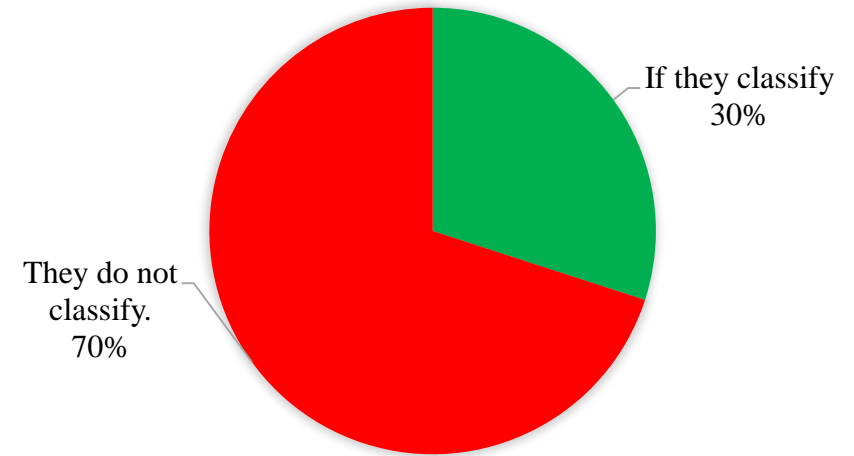

Treatment of waste by the community

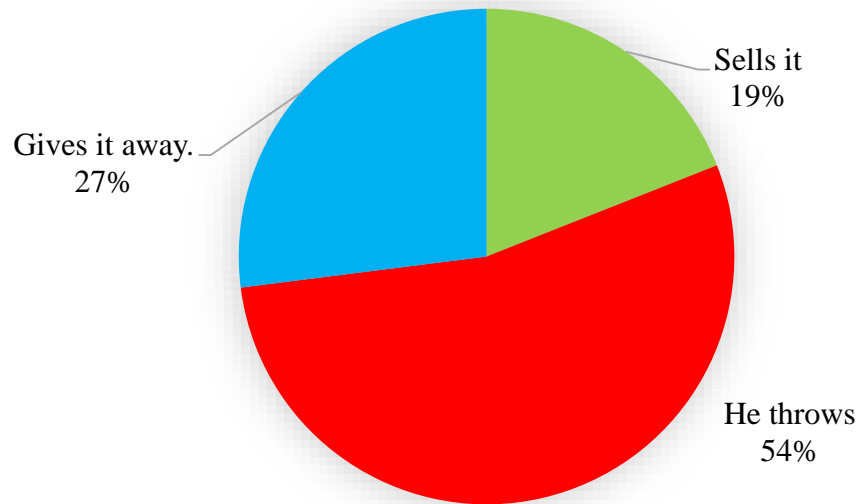

Knowledge of collection systems.

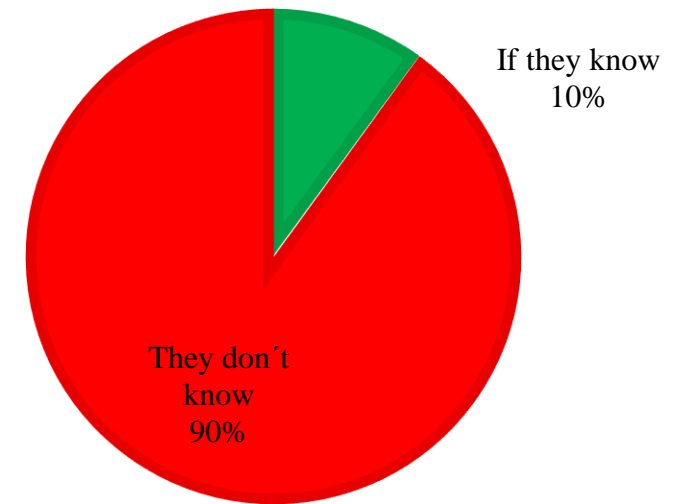

Consultation Source: Own elaboration with data obtained from the survey

Results of the value chain analysis

Phase 1: Choice of a product family

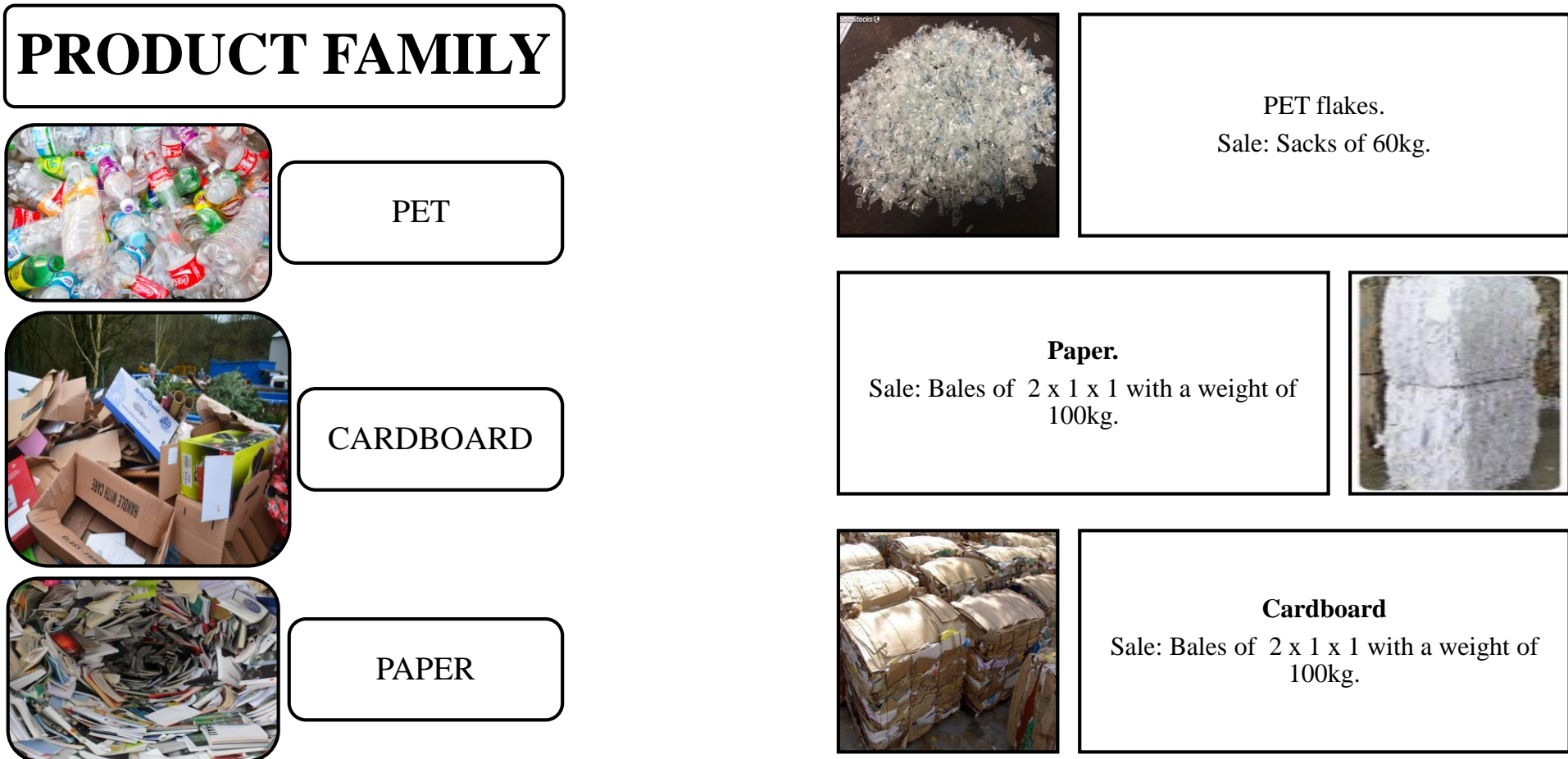

Consultation Source: Own Elaboration

Results of the value chain analysis Phase 2. Mapping the initial situation

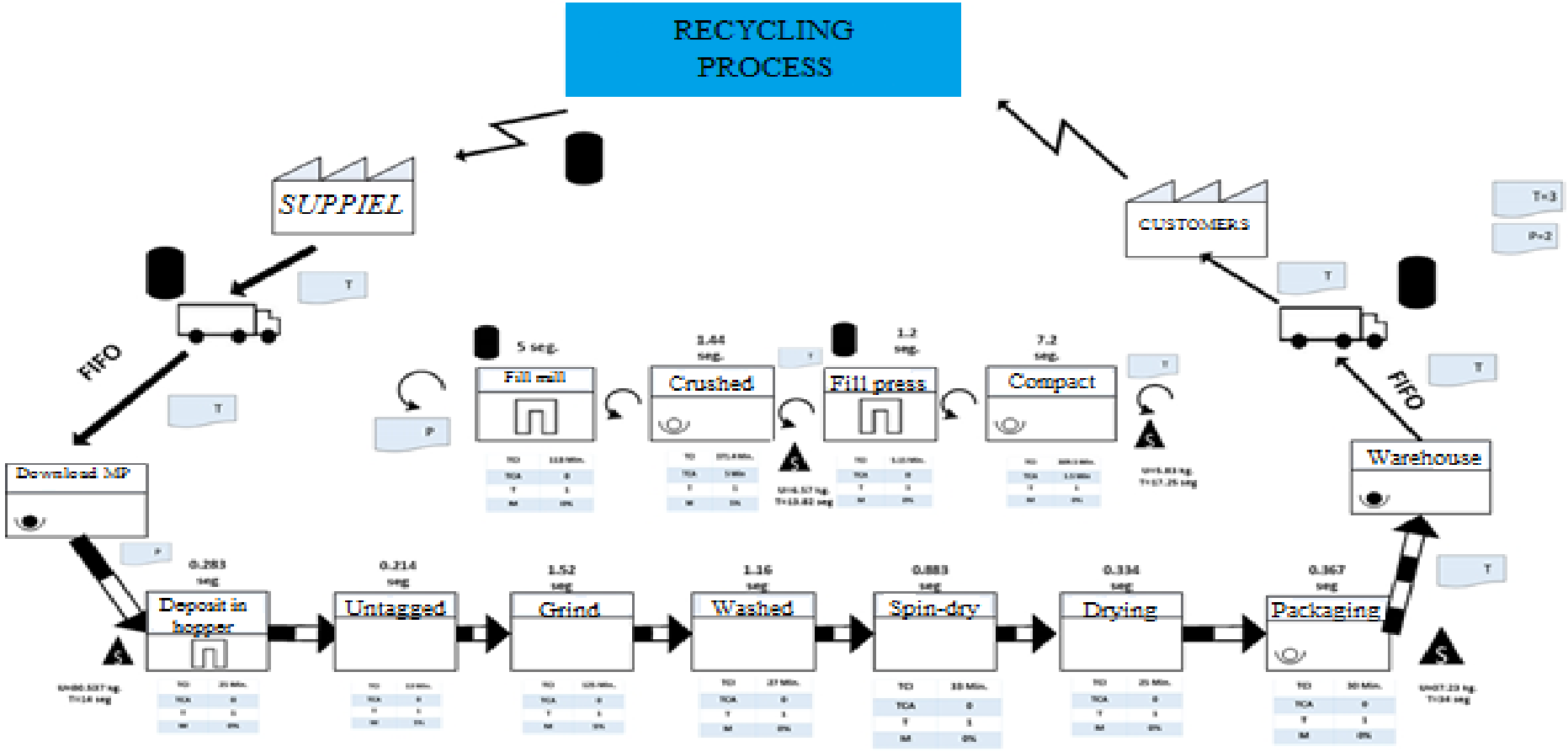

Consultation Source: Own Elaboration

Development and design of a recycling plant prototype

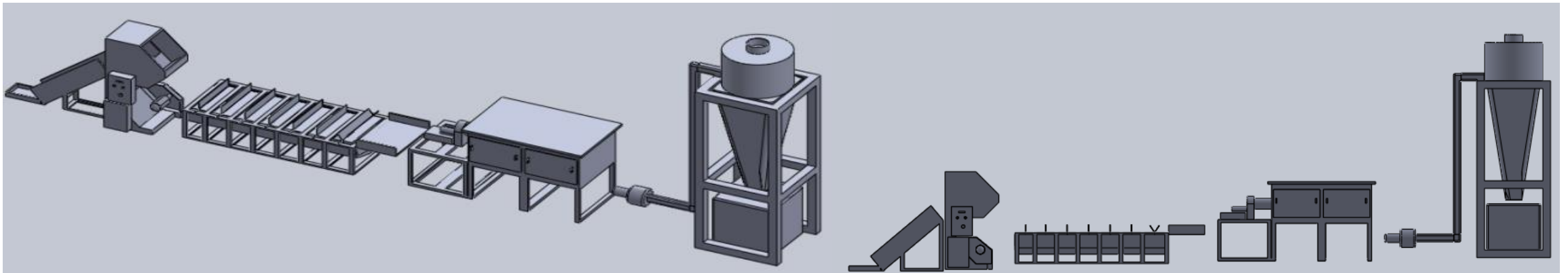
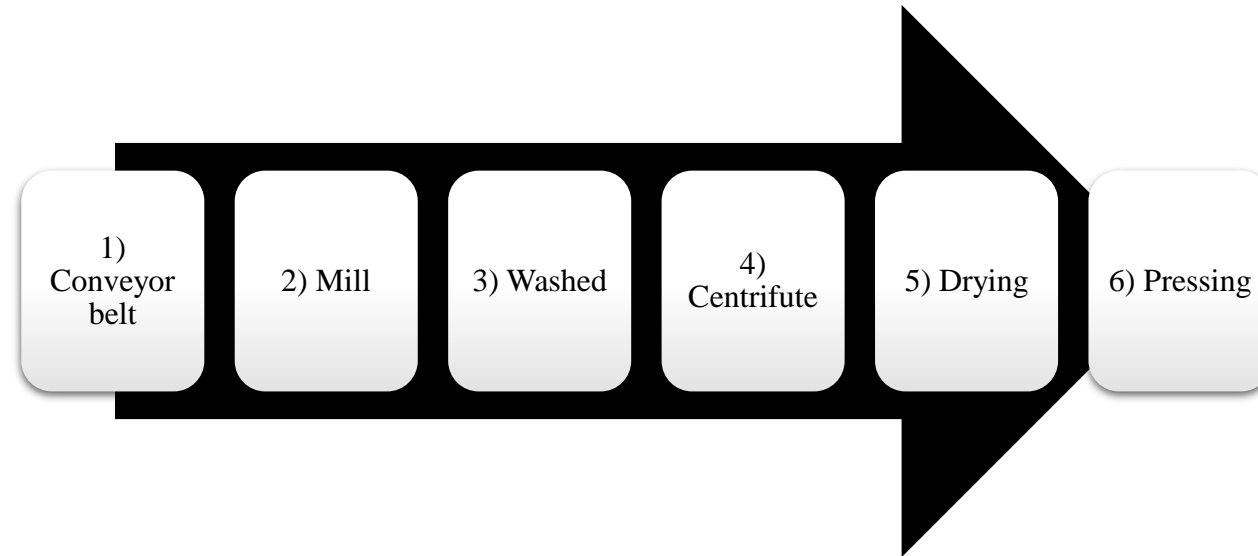

Consultation Source: Own Elaboration, SolidWorks 2012

Conclusions

Fulfilling the objectives set at the beginning of this research and following the suggested methodology. A study of the value chain of the PET, cardboard and paper recycling process was carried out, in which the operations, machinery, and client suppliers that comprise it were identified. The potential MSW for the recycling process was determined, a projection was made to visualize the number of kilograms that are generated and are daily, in the same way the inhabitants of the two municipalities were involved through the application of a survey which was a guideline for determine the acceptance or rejection of the project; Subsequently, the optimal prototype was designed in SolidWorks technological software. What was described above allowed us to assess the proposal to open a recycling plant in the Sierra Norte of the State of Puebla.

The analysis presented is relevant, because it will guarantee a sustainable consumption and production modality through recycling; supporting the fulfillment of Sustainable Development Goal number 12 of the 2030 Agenda, the establishment of the recycling plant to serve the municipalities of Huauchinango and Xicotepec will promote the efficient use of MSW; The correct application of the designed production lines will contribute to the achievement of the municipal development plans that derive from the reduction of polluting sources for the environment, reducing the main problem of the effects produced by the consumption of products with PET, cardboard and paper, having economic, social but mainly environmental impacts.

References

- Arboleda Germán, Proyectos, Formulación, Evaluación y Control, Editorial San Fernando Cali – Colombia, año 2007.
- Buchenau, M., & Suri, J. F. (2000, August). Experience prototyping. In Proceedings of the 3rd conference on Designing interactive systems: processes, practices, methods, and techniques (pp. 424-433). ACM
- Cinta transportadora modular de ANIS TREND d.o.o. DirectIndustry. (2020). Consultado el 24 de diciembre de 2020, de <https://www.directindustry.es/prod/anis-trend-doo/product-200888-2143467.html>
- CORFO. (2016). Prototipos. In *Corfo.cl* (p. 6). Retrieved from Creative Commons website: https://innovacioncomunitaria.files.wordpress.com/2018/10/prototipos_corfo0.pdf
- Escobar, A., Quintero, D., & Serradas, D. (2006). *El reciclaje como instrumento para la concientización de la conservación del ambiente, en el Preescolar “Mi Casita de Colores”* (Thesis; p. 32). Retrieved from <http://biblioteca2.ucab.edu.ve/anexos/biblioteca/marc/texto/AAQ6004.pdf>
- Espinoza Oscar, Folleto Segregación, Reciclaje y Comercialización de los Residuos Sólidos, Primera Edición, Lima año 2005.

- Frances, A. (2001). Estrategias para la Empresa en la América Latina. Ediciones IESA Caracas.
- Gabriel Quadri (2006). *Políticas Públicas. Sustentabilidad y medio ambiente*, en prensa, Miguel Ángel Porrúa, México, p.22
- Gerstein, Marc S. (1988). Encuentro con la tecnología. Estrategias y cambios en la era de la información. Addison Wesley Iberoamericana, México
- HILL, CH. JONES, G (2001). “Administración Estratégica”. Un Enfoque Integrado. Editorial McGraw-Hill. Tercera Edición. Bogotá.
- <http://femsa.com/es/assets/003/15669.pdf>
- IMER (2010) Industria Mexicana de Reciclaje, S.A. de C.V. Recuperado en:
- INEGI (2010) Instituto Nacional de Geografía e Informática. Recuperado en: <http://www.inegi.gob.mx>
- Kotter, P. (2004). Fundamentos de Mercadotecnia. Prentice-Hall.
- Los molinos trituradores en el proceso de reciclaje de plásticos. (2020). Consultado el 24 de diciembre de 2020, de <https://www.interempresas.net/Plastico/Articulos/197049-Los-molinos-trituradores-en-el-proceso-de-reciclaje-de-plasticos.html>

- Masapanta Serpa, M. R. (2014). *Análisis de despilfarros mediante la técnica value stream mapping (VSM) en la fábrica de calzado lenical* (Thesis; p. 31). Retrieved from <http://dspace.ucuenca.edu.ec/bitstream/123456789/20654/1/TESIS.pdf>
- NAPCOR The National Association for PET Container Resources. Recuperado en: <http://www.napcor.com/index.html>
- PAREDES-RODRÍGUEZ, Andrés Mauricio. Aplicación de la herramienta Value Stream Mapping a una empresa embaladora de productos de vidrio. En: *Entramado*. Enero - Junio, 2017. Vol. 13, no. 1, p. 262-277 <http://dx.doi.org/10.18041/entramado.2017v13n1.25103>
- Porter, M. (1986). *Ventaja Competitiva*. Editorial C.E.C.S.A. México.
- Prensa eléctrica para cartón y plástico E319. (2020). Consultado el 24 de diciembre de 2020, de <https://www.miltek.com.mx/product/prensa-electrica-para-carton-y-plastico-e319>
- Prensas y Compactadoras de Residuos. (2020). Consultado el 24 de diciembre de 2020, de <https://www.miltek.com.mx/prensas-y-compactadoras>
- Quintero, Johana, & Sánchez, José (2006). La cadena de valor: Una herramienta del pensamiento estratégico. *Telos*, 8(3) ,377-389. [Fecha de Consulta 13 de Mayo de 2021]. ISSN: 1317-0570. Disponible en: <https://www.redalyc.org/articulo.oa?id=99318788001>

- Quiñones S. (2015) Larga vida al PET. Revista Expansión, Ed. 874. Recuperado en: <http://www.expansión.com.mx/default.asp>
- RAE. (2020). Diccionario de la lengua española RAE - ASALE. Retrieved May 13, 2021, from “Diccionario de la lengua española” - Edición del Tricentenario website: <https://dle.rae.es/prototipo>
- Reyes Curcio, A., Pellegrini Blanco, N., & Reyes Gil, R. E. (2015). El reciclaje como alternativa de manejo de los residuos sólidos en el sector minas de Baruta, Estado Miranda, Venezuela. *Revista de Investigación*, 39(86), 157–170. Retrieved from <https://www.redalyc.org/jatsRepo/3761/376144131008/html/index.html>
- Sandoval Alvarado Leonardo, Folleto Disposición Final y Tratamiento de los Residuos Sólidos, Primera Edición, Lima 2005.
- SEMARNAT. (2012). Compendio de Estadísticas Ambientales. Retrieved May 13, 2021, from Semarnat.gob.mx website: [https://apps1.semarnat.gob.mx:8443/dgeia/Compendio_2012/dgeiawf.semarnat.gob.mx_8080/ibi_apps/WFServlet5c54.html#:~:text=Recolecci%C3%B3n%20selectiva%20\(separada%20o%20segregada,separaci%C3%B3n%20de%20los%20materiales%20valorizables](https://apps1.semarnat.gob.mx:8443/dgeia/Compendio_2012/dgeiawf.semarnat.gob.mx_8080/ibi_apps/WFServlet5c54.html#:~:text=Recolecci%C3%B3n%20selectiva%20(separada%20o%20segregada,separaci%C3%B3n%20de%20los%20materiales%20valorizables).
- Thompson, A. Strickland III, A. (2000). Administración Estratégica. Conceptos

- Tipo Horizontal De Plástico Para Mascotas De Bomba Centrífuga De Secador - Comprar Centrífugo Secador de Copos De Pet, Secador De Copos De Pet Máquina de Secado de Plástico Producto en Alibaba.com. (2020). Consultado el 24 de diciembre de 2020, de <https://spanish.alibaba.com/product-detail/horizontal-type-plastic-pet-flakes-centrifugal-dryer-1968680854.html>
- Torres Guarniz, G. (2016). *El uso de facturas falsas en la compra de productos reciclables de la empresa* (Thesis; p. 16). Retrieved from http://repositorio.usanpedro.edu.pe/bitstream/handle/USANPEDRO/10599/Tesis_60899.pdf?isAllowed=y&sequence=1



ECORFAN®

© ECORFAN-Mexico, S.C.

No part of this document covered by the Federal Copyright Law may be reproduced, transmitted or used in any form or medium, whether graphic, electronic or mechanical, including but not limited to the following: Citations in articles and comments Bibliographical, compilation of radio or electronic journalistic data. For the effects of articles 13, 162,163 fraction I, 164 fraction I, 168, 169,209 fraction III and other relative of the Federal Law of Copyright. Violations: Be forced to prosecute under Mexican copyright law. The use of general descriptive names, registered names, trademarks, in this publication do not imply, uniformly in the absence of a specific statement, that such names are exempt from the relevant protector in laws and regulations of Mexico and therefore free for General use of the international scientific community. BCIERMMI is part of the media of ECORFAN-Mexico, S.C., E: 94-443.F: 008- (www.ecorfan.org/booklets)